

CAD FILE:

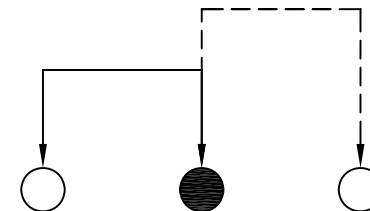

SCHEMATIC (NON-SHORTING)

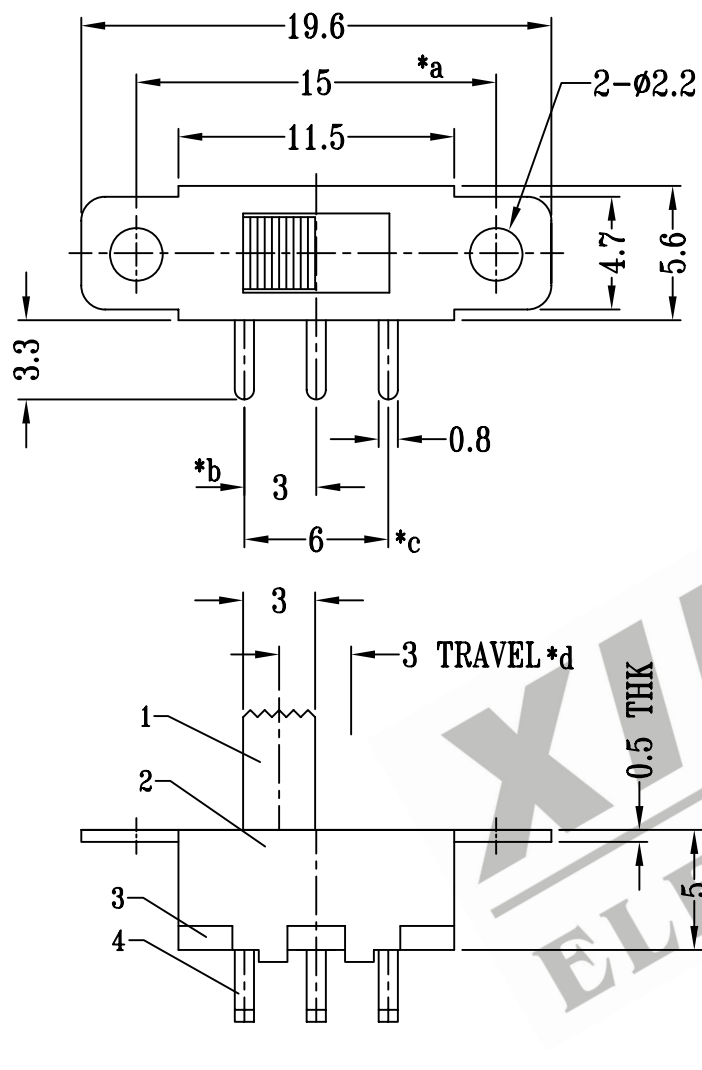
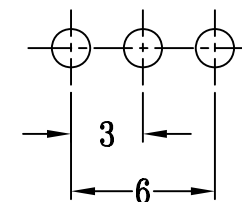

P.C.B LAYOUT

注:带"\*"表示关键尺寸(6个)

NO.	PARTS	MATERIALS	Q'TY	FINISH	TOLERANCE UNLESS SPECIFIED	SHENZHEN XIEJIA ELECTRONICS CO.,LTD.				
8						TITLE : VERTICAL SLIDE SWITCH MODEL: SS-12F117 ALL MATERIALS MUST BE COMPLIANT TO ROHS				
7										UNIT : mm
6	CONTACT CLIP	COPPER STRIP	1	Ag PLATED	WITHIN : 1.5±0.1mm OVER : 1.5±0.2mm	ISSUE	DATE	DESCRIPTIONS OF REVISION		APPD.
5	SPRING	STEEL WIRE	1	TEMPER				DWN.	ZHOUYU	2003-4-22
4	TERMINAL	BRASS STRIP	3	Ag PLATED OVER Ni PLATED				CHK'D	FANGYING	2003-4-22
3	BASE	PHENOLIC RESIN	1	NATURAL				APPD.	KANGXINAN	2003-4-22
2	FRAME	STEEL STRIP	1	BLACK						
1	KNOB	POM	1	BLACK						